



Rotating cleaning nozzle »MiniSpinner 2« Series 5M3

NEW

Series 5M3

The MiniSpinner 2 convinces with its popular design and effective cleaning. The MiniSpinner 2 is made entirely from stainless steel and designed for use also at high temperatures. It is available with many different flow rates and spray angles.

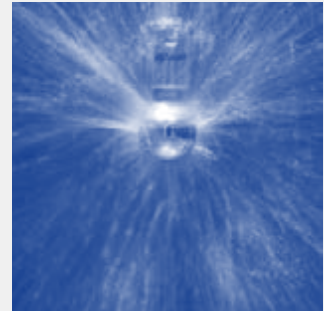

Function video

Scan the QR-Code or go to:

www.lechler.com/de-en/medialibrary



Max. tank diameter [m]

0 | 1 | 2 | 3 | 4 | 5 | 6 | 7 | 8 | 9



Materials

Stainless steel 316L



Max. temperature

250 °C



Recommended operating pressure

2 bar



Installation

Operation in every direction is possible



Filtration

Line strainer with a mesh size of 0.1 mm/170 Mesh



Bearing

Double ball bearing made of stainless steel 316L







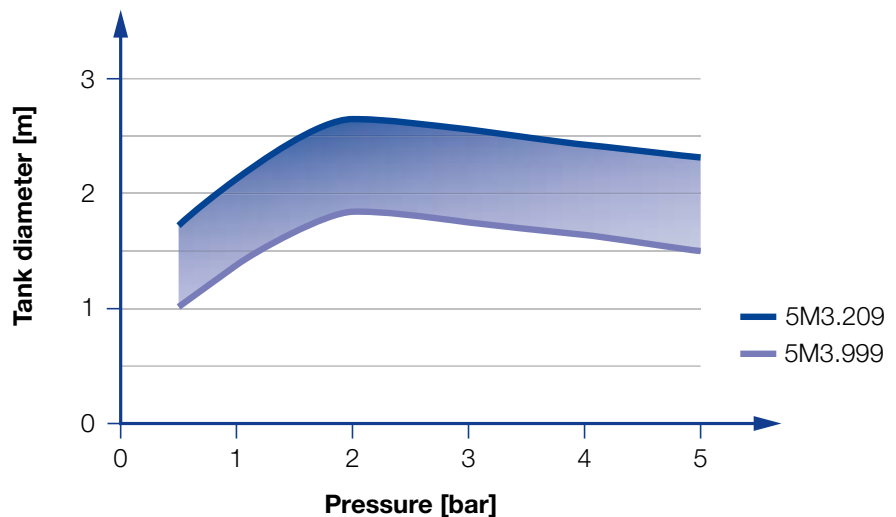

Adapter

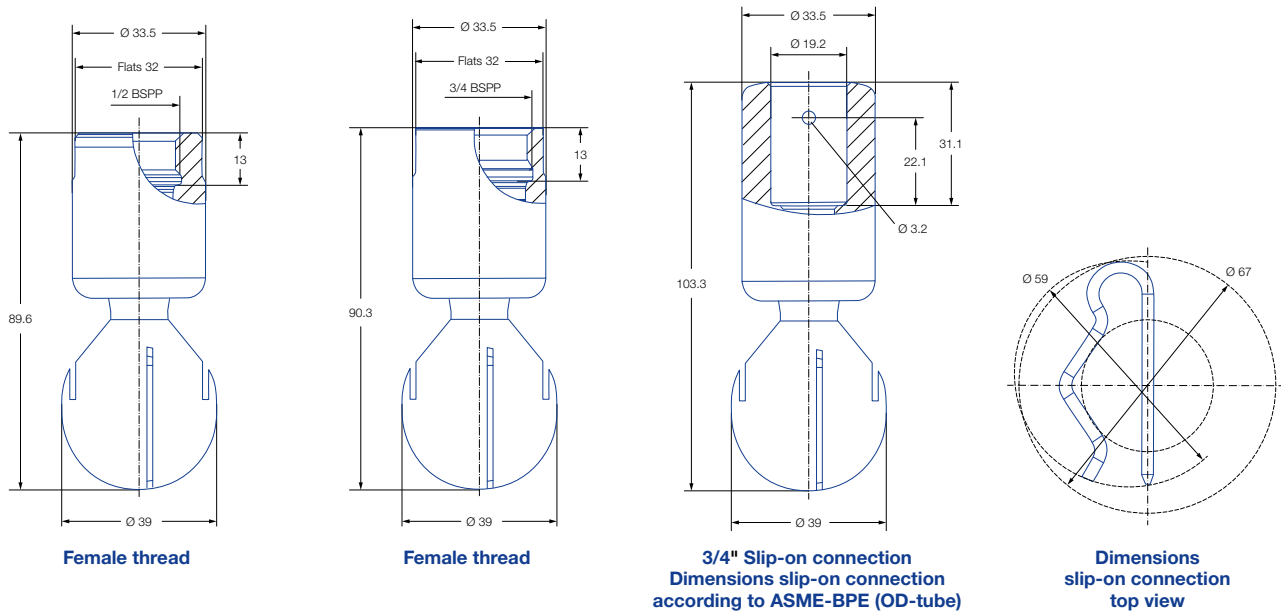
1/2 BSPP and 3/4 BSPP are compatible with HygienicFit



Overview of the tank diameter, depending upon the pressure of series 5M3



Spray angle 	Ordering number				E Ø [mm]	V̇ [l/min]					Max. tank diameter [m]
	Type	Connection				p [bar] (p _{max} = 7 bar)					
		1/2 BSPP	3/4 BSPP	3/4" Slip-on		1	2	3	at 40 psi [US gal./min]		
60° 	5M3.122.1Y	AH	-	TF07	2,6	45	63	77	20	-	
180° 	5M3.133.1Y	-	AL	TF07	1,2	47	67	82	21	2,6	
180° 	5M3.134.1Y	-	AL	TF07	1,3	47	67	82	21	2,6	
360° 	5M3.999.1Y	-	AL	TF07	0,4	21	30	37	9	1,8	
	5M3.089.1Y	-	AL	TF07	0,7	35	49	60	15	2,1	
	5M3.139.1Y	-	AL	TF07	0,8	49	69	85	21	2,3	
	5M3.209.1Y	-	AL	TF07	1,5	71	100	122	31	2,6	

E = narrowest free cross-section
NPT, slip-on connection and weld-on versions on request

The maximum tank diameter shown above applies for the recommended operating pressure and is indicative only. The cleaning result is also affected by the type of soiling.

Information on operation



- Operation with compressed air only for short-term usage. Operation above the recommended operating pressure means higher wear and smaller droplets. This might have adverse effects on the cleaning result.

Slip-on information

- Split pin made of 316L SS is included. (Ordering no.: 05M.330.1Y.00.00.0).
- Depending on diameter of the adapter the flow rate can increase due to leakage between connecting pipe and rotating cleaning nozzle.
- Minimum insertion diameter (with mounted split pin) is 59 mm.

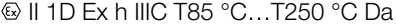
Example of ordering with ATEX approval. FDA and (EG) 1935/2004 conform.
Only material 316L SS available with ATEX approval.



Unit group / category / zones:
 II 1G Ex h IIB T6...T2 Ga
 II 1D Ex h IIIC T85 °C...T250 °C Da

Example of ordering: Type 5M3.122 + 1Y + Mat. no. + Connection = Ordering no.
 ordering: 5M3.122 + 1Y + AH = 5M3.122.1Y.AH.EX

Example of ordering with FDA and (EC) 1935/2004 conformity.

All Materials are suitable for contact with food.

Example of ordering: Type 5M3.122.1Y + Connection = Ordering no.
 ordering: 5M3.122.1Y + AH = 5M3.122.1Y.AH

Attention: for the ATEX version of the slip-connection the code for the connection changes. Ordering example for connection: 5M3.122.1Y.T2.EX