

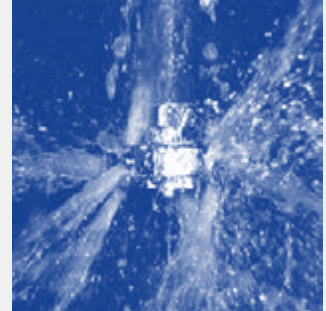

Rotating cleaning nozzles »Gyro« Series 577

Series 577

The Gyro cleans with powerful nozzle inserts and is available in many flow rates and spray angles. It is also suitable for very large tanks and is insensitive to clogging.



Function video
Scan the QR-code or go to:
www.lechler.com/gyro



Max. tank diameter [m]



Materials
316L SS, PTFE



Max. temperature
90 °C



Recommended operating pressure
3 bar



Installation
Vertically facing downward



Filtration
Line strainer with a mesh size of 0.3 mm/50 mesh



Bearing
Slide bearing made of PTFE





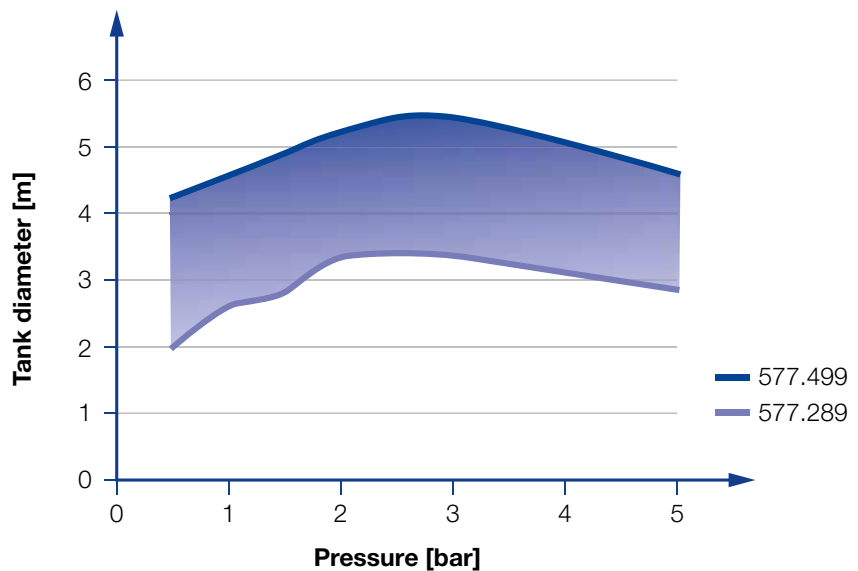

Accessories
Spare parts set consisting of:
top seal, bottom seal, bolt, nut, sleeve, instructions for use

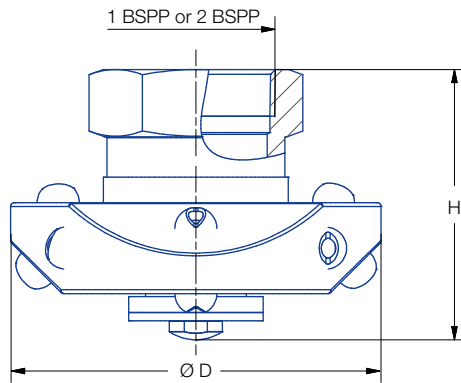

Overview of the tank diameter, depending upon the pressure of series 577



Female thread

Spray angle 	Ordering no.			\dot{V} [l/min]					Dimensions		Max. tank diameter [m]
	Type	Connection		p [bar] ($p_{max} = 5$ bar)					Height H [mm]	Diameter D [mm]	
		1 BSPP	2 BSPP	1	2	3	5	at 40 psi [US gal/min]			
180° 	577.283.1Y	AN	-	115	163	200	258	50	72	118	3.4
	577.363.1Y	AN	-	182	258	316	408	80	72	118	3.9
	577.403.1Y	-	AW	228	322	394	509	100	103	156	4.2
	577.433.1Y	-	AW	273	386	473	610	120	103	156	4.6
	577.523.1Y	-	AW	452	639	783	1,010	170	103	156	5.4
180° 	577.284.1Y	AN	-	115	163	200	258	50	72	118	3.4
	577.364.1Y	AN	-	182	258	316	408	80	72	118	3.9
	577.404.1Y	-	AW	228	322	394	509	100	103	156	4.2
	577.434.1Y	-	AW	273	386	473	610	120	103	156	4.6
	577.494.1Y	-	AW	380	538	659	851	170	103	156	5.4
270° 	577.285.1Y	AN	-	115	163	200	258	50	72	118	3.4
	577.365.1Y	AN	-	182	258	316	408	80	72	118	3.9
	577.405.1Y	-	AW	228	322	394	509	100	103	156	4.2
	577.435.1Y	-	AW	273	386	473	610	120	103	156	4.6
	577.495.1Y	-	AW	380	538	659	851	170	103	156	5.4
360° 	577.289.1Y	AN	-	115	163	200	258	50	72	118	3.4
	577.369.1Y	AN	-	182	258	316	408	80	72	118	3.9
	577.409.1Y	-	AW	228	322	394	509	100	103	156	4.2
	577.439.1Y	-	AW	273	386	473	610	120	103	156	4.6
	577.499.1Y	-	AW	380	538	659	851	170	103	156	5.4

NPT on request

The maximum tank diameter shown above applies for the recommended operating pressure and is indicative only. The cleaning result is also affected by the type of soiling.

Information on operation

- Operation with compressed air only for short-term usage. Operation above the recommended operating pressure has negative effects on the cleaning result and wear.

Example for Ordering: Type 577.283.1Y. + Connection AN = Ordering no. = 577.283.1Y.AN